

## Sistema solaio Walk-Deck LT

Systeme dalle Walk-Deck LT

Walk-Deck LT slab fromwork system

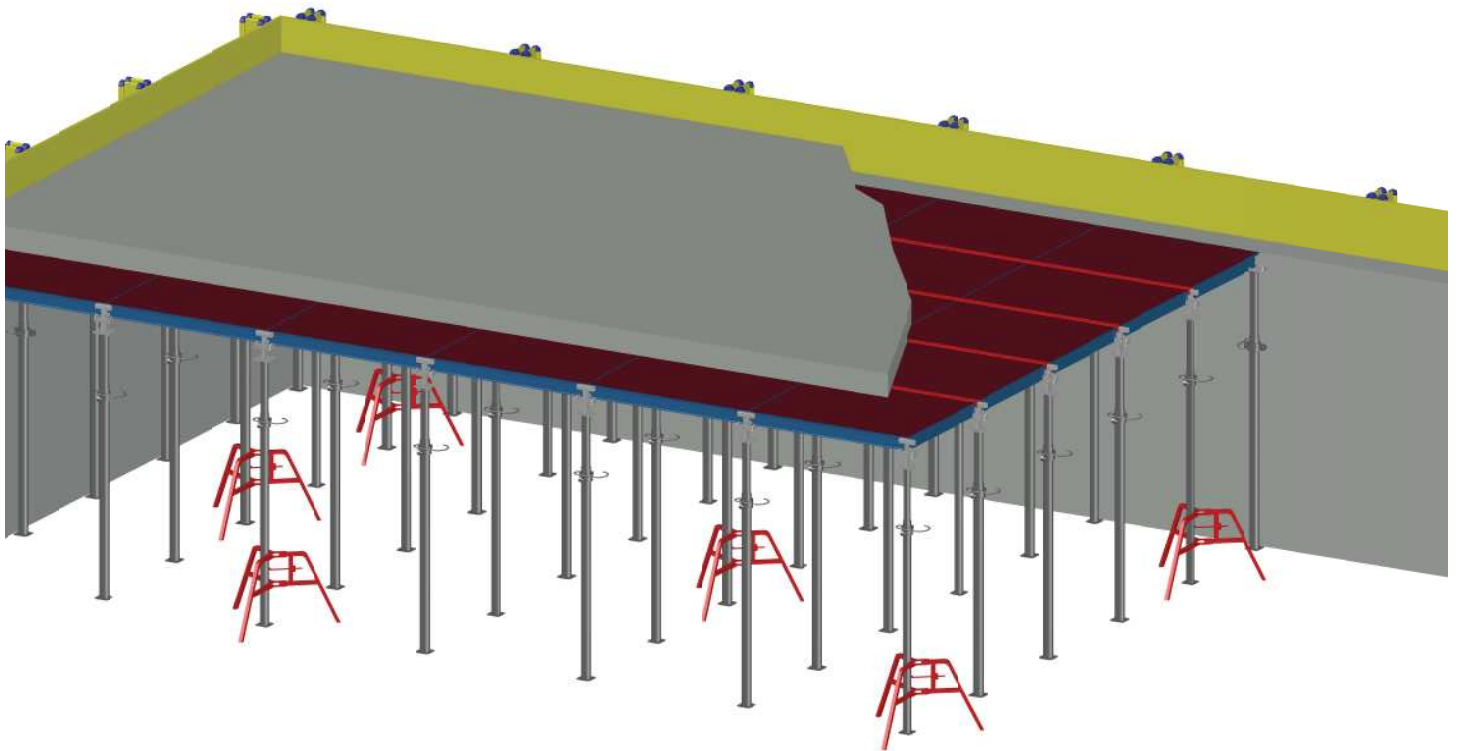

[www.nicoletti-international.com](http://www.nicoletti-international.com)





**INA**<sup>®</sup>  
SINCE 1965

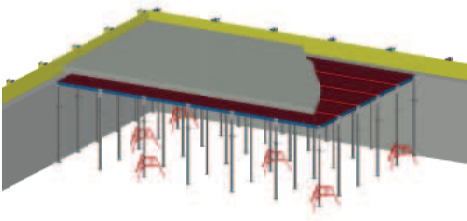

**Sistema Walk-Deck LT** **1/36**  
**Systeme dalle Walk-Deck LT**  
**Walk-Deck LT slab formwork system**



**Puntellazione** **25/36**  
**Etais**  
**Propping**

## SOLAIO - DALLE - FLOOR

**Sistema solaio Walk-Deck LT**  
Systeme de coffrage de dalle Walk-Deck LT  
Walk-Deck LT slab formwork system

1/36

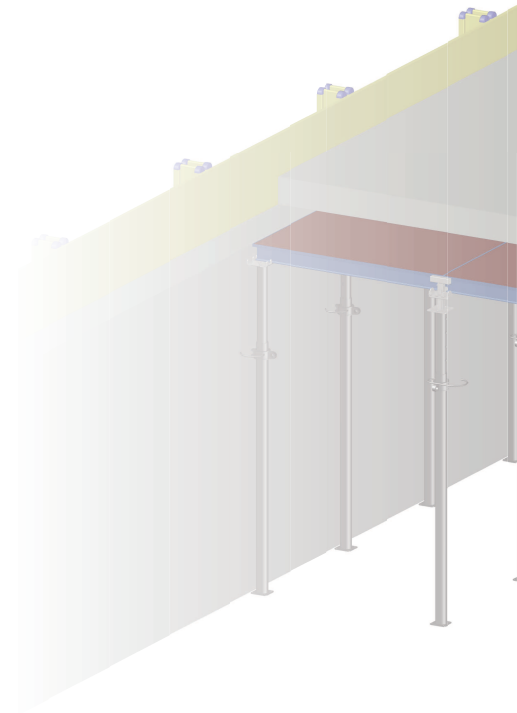

Per il corretto utilizzo di ogni sistema di prodotto è obbligato consultare il relativo manuale d'uso.  
Esso può subire costanti aggiornamenti e revisioni senza nostro preavviso.  
E' responsabilità dell'utilizzatore assicurarsi di essere in possesso della versione più recente del manuale stesso.

Pour la bonne utilisation de chaque système de produit est nécessaire, se référer au manuel d'utilisation.  
Il peut subir des mises à jour et des révisions constantes sans notre avis.  
Et la «responsabilité de vous assurer que vous avez la dernière version du manuel.

For the proper use of each product system is obliged to consult the user's guide.  
It can undergo constant updates and revisions without our notice.  
E' responsibility to ensure that you have the latest version of the manual.

# Sistema solaio Walk-Deck LT

## Systemes pour dalle Walk-Deck LT

### Walk-Deck LT slab formwork system

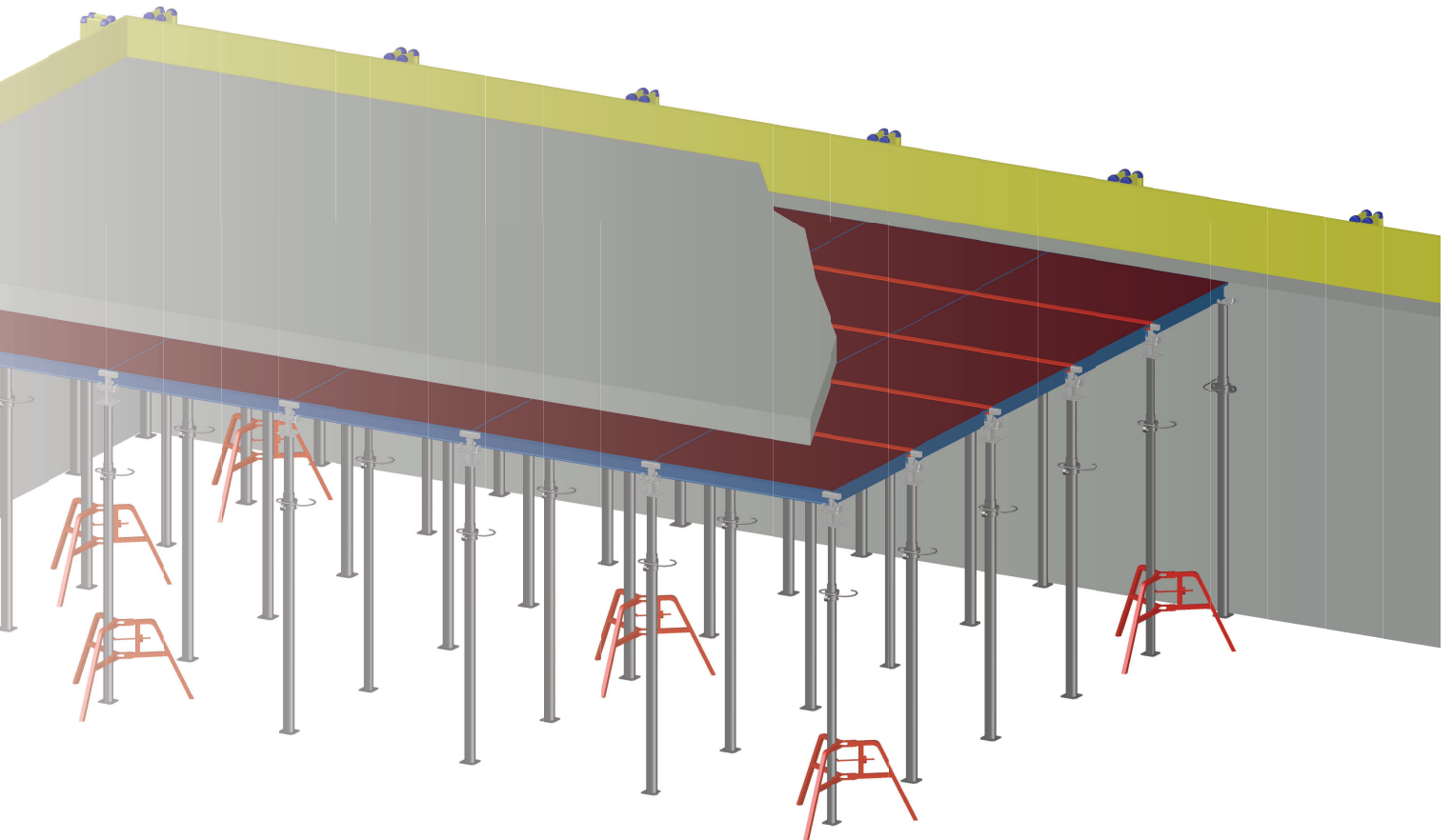

**Sistema Walk-Deck LT**  
**Systeme dalle Walk-Deck LT**  
**Walk-Deck LT slab formwork system**



Il sistema Walk-Deck LT serve a realizzare l'armatura di solette con spessore non superiore a 30 cm con la configurazione 150x112,5 cm.

E' composto principalmente dai pannelli in alluminio appoggiati a delle teste cadenti o a delle teste fisse sorrette da puntelli in acciaio ad alta portata.

Visto che il montaggio avviene esclusivamente a mano da parte dell'operatore abbiamo ritenuto necessario progettare e realizzare tutti gli elementi con un peso adeguato, pur mantenendone la solidità, per rendere agevoli e veloci le operazioni di montaggio e smontaggio.

Considerata l'ampia gamma di misure dei pannelli, questo

Le système Nicoletti International pour dalle LT est utilisé pour mettre en œuvre l'armure de dalle d'une épaisseur ne dépassant pas 30 cm avec la configuration 150x112,5 cm.

Et 'composée principalement de panneaux en aluminium appuyé contre les têtes de decintrement têtes fixes ou soutenues par des Etais en acier à haute capacité.

Comme l'assemblage se fait exclusivement à la main par l'opérateur nous avons jugé nécessaire de concevoir et fabriquer tous les éléments avec un poids approprié, tout en maintenant la solidité, de faciliter et plus rapides les opérations de montage et de démontage.

Compte tenu de la large gamme de tailles des panneaux en Aluminium, ce système réduit au minimum le nombre de

The Nicoletti International Walk-Deck LT System, serves you to achieve the armor of slabs with a thickness not exceeding 30 cm with the configuration 150x112,5 cm. The System is constituted by: mainly of aluminum panels leaning by drop heads and fix heads according to the type of floor, all of this are supported by High capacity Steel props.

As the assembly is done exclusively by hand, by the site operator we decided to design and implement all elements with an appropriate weight, while maintaining the strength, to make easier and quicker the operations of assembly and disassembly.

Considering the wide range of sizes of the panels, this sy-

stema riduce al minimo possibile il numero di casi in cui il sistema Walk-Deck LT non può intervenire riducendo la necessità di compensazioni in legno.

Laddove sia comunque necessaria la compensazione in legno, per esempio nel giro pilastri o al termine delle pareti, la Nicoletti International ha previsto una serie di accessori, illustrati successivamente, in grado di velocizzare in modo sicuro eventuali compensazioni.

Il maggior punto di forza di questo sistema è quello di poter disarmare, grazie al disarmo della testa cadente, tutti i pannelli dopo pochi giorni dalla fase di getto, recuperando così quasi tutto il materiale per la fase successiva.

cas dans lesquels le système ne peut pas intervenir nostre system de Dalle LT réduire la nécessité d'une indemnisation en bois.

Où il est cependant compensation nécessaire en bois, par exemple dans autour de piliers ou à la fin des murs, Nicoletti Int. a fourni une série d'accessoires, illustré ci-dessous, en mesure d'accélérer en toute sécurité les éventuelles compensations.

La plus grande force de ce système est de pouvoir désarmer grâce au désarmement de la tête de decintrement qui tombe, tous les panneaux après quelques jours de l'étape de coulée, récupérant ainsi la totalité de la matière pour la prochaine étape.

stem reduces to a minimum the number of cases in which the system can not be used Walk-Deck LT reducing the need for compensation in wood.

Where it is however necessary compensation in wood, for example: around pillars or at the end of the walls, the Nicoletti International has provided a series of accessories, illustrated below, able to speed safely any compensations. The main strength of this system is to be able to disarm in advance compared to the traditional system (H2O beams and Steel Props), thanks to the disarming of the falling head all panels after a few days from the casting stage, thus recovering almost all of the material for the phase next.

## Pannelli

### Panneaux

### Panels

Questi pannelli costruiti interamente in alluminio sono stati creati per un semplice montaggio e smontaggio visto il loro limitato peso. Possono essere forniti con multistrato di betulla 9 mm o, a richiesta, con multistrato di betulla con rivestimento plastico.

Ces panneaux, entièrement construits en aluminium, ont été créés pour un montage et un démontage simples vu leur poids limité. Ils peuvent être fournis en bouleau multiplis de 9 mm ou bien, sur demande, avec du bouleau multiplis avec revêtement en plastique.

These panels built entirely in aluminium have been created with a simple action of assembling and dismantling considering their limited weight. They can be supplied in multi-layer of birch with plastic covering.

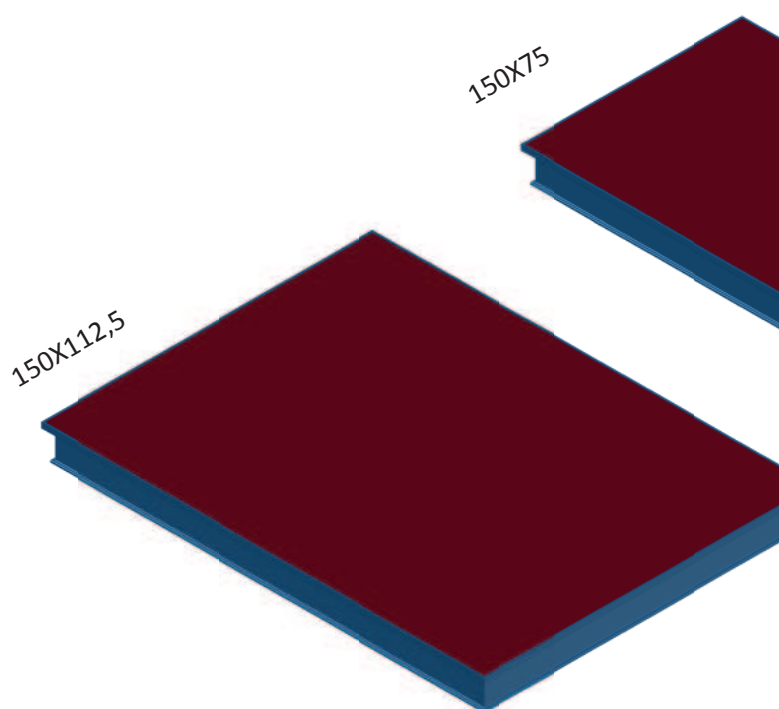

**PANNELLI SOLAIO  
PANNEAUX DALLE  
SLAB PANELS**

DESCRIZIONE DESCRIPTION DESCRIPTION	ARTICOLO ARTICLE ARTICLE	PESO Kg POIDS Kg WEIGHT Kg	M <sup>2</sup> M <sup>2</sup> M <sup>2</sup>
150X112,5	311109	21,7	1,6875
150X75	311110	15,7	1,125
150X50	311112	12,1	0,75
150X37,5	311114	9,9	0,5625
75X75	311116	8,8	0,5625
75X50	311118	6,7	0,375
75X37,5	311120	5,5	0,28125

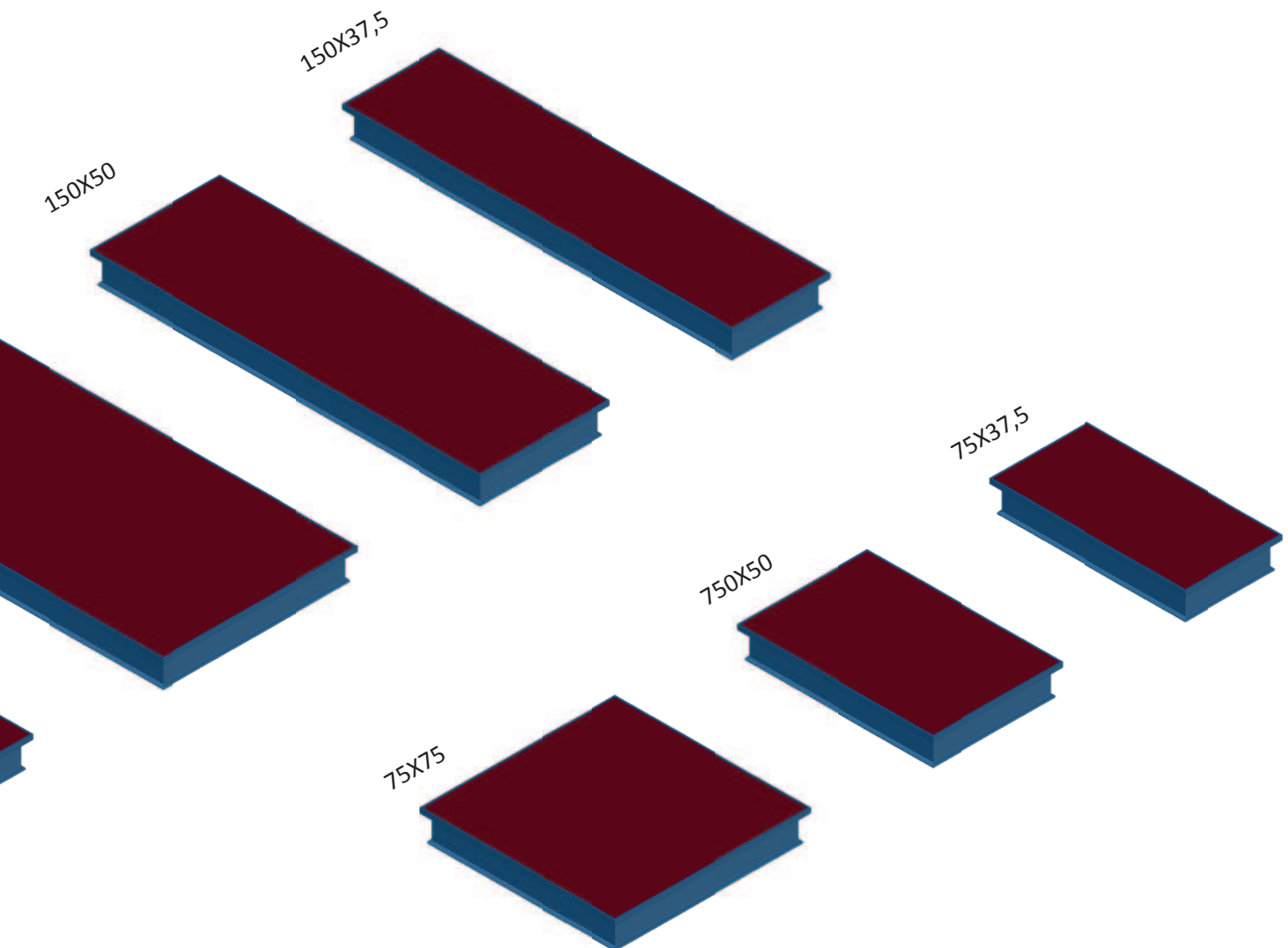



**Testa cadente LT**  
**Têtes de décoffrage LT**  
**Falling head LT**

TESTA CADENTE LT TÊTES DE DÉCOFFRAGE LT FALLING HEAD LT		
DESCRIZIONE DESCRIPTION DESCRIPTION	ARTICOLO ARTICLE ARTICLE	PESO Kg POIDS Kg WEIGHT Kg
	391010LT	4,2

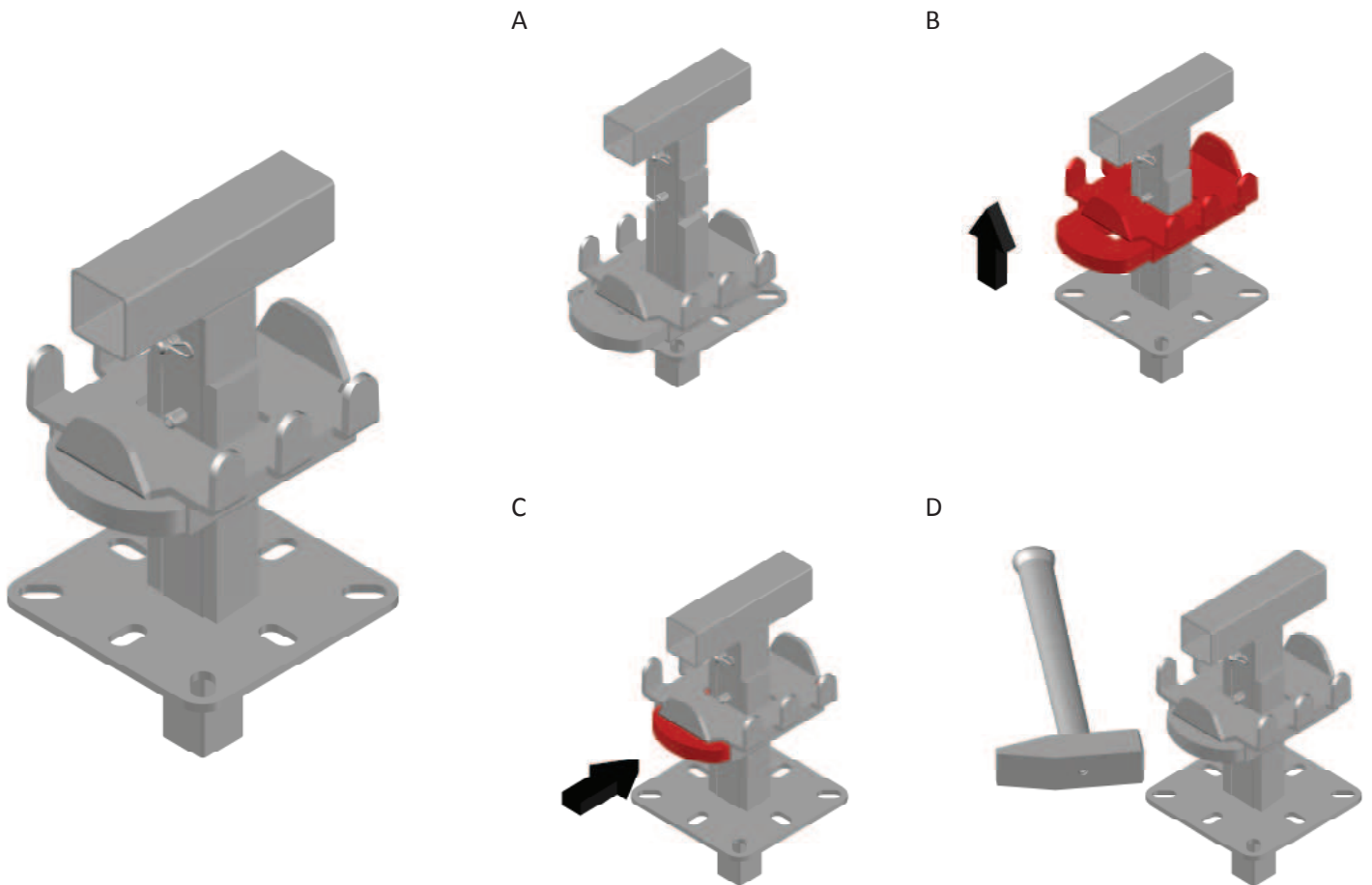

Questo importante accessorio viene utilizzato al 90% durante l'armatura di un solaio. La testa cadente va inserita nel puntello e fissata tramite bulloni; essa permette, una volta armata, l'alloggiamento di quattro angoli di pannelli solaio.

Fasi di armatura:

Fig. A – B Sollevare l'appoggio dei pannelli e relativo cuneo

Fig. C Infilare il cuneo conico nell'apposita sede

Fig. D Serrare tramite martello il cuneo.

Per la fase di disarmo è sufficiente agire con il martello sul cuneo in modo da far cadere l'appoggio dei pannelli della testa e i relativi pannelli sostenuti.

La testa cadente è stata realizzata completamente smontabile in modo tale da poterle fare il trattamento superficiale con zincatura a caldo a richiesta del cliente.

Cet accessoire important est utilisé à 90% au cours de l'armure d'un étage. La tête de decintrement est inséré dans l'E-tais charge et fixée par des boulons; il permet, une fois armé, le logement des panneaux de plancheur (quatre coins des panneaux pour chaque tete).

Phases de montage du plancher:

Fig. A – B Relever les support de panneaux avec son coin.

Fig. C Insérez le coin conique en place

Fig. D Serrez la cale d'un coup de marteau.

Pour l'étape du désarmement est suffisante, agir avec le marteau sur la cale de manière à laisser tomber le support des panneaux de la tête de decintrement et les panneaux relatifs encourus.

La tête de decintrement a été conçu dans l'ensemble amovible de sorte qu'ils puissent faire le traitement de surface en peinture où de galvanisation à chaud selon la demande du client.

This important accessory is used up to 90% during the arming phase of a floor. The drop head is inserted into the steel prop and secured by bolts; it allows, once armed, the housing of four ceiling panels (1 corner for each panel).

Assembly Phases:

Fig. A – B Lift up the support of the panels and its wedge

Fig. C Insert the tapered wedge into place

Fig. D Tighten the wedge with a hammer blow.

For the process of disarmament is sufficient to act with the hammer on the wedge, sliding sideways, this will drop down the moving part of the head. In that case all panels will drop down and you will create the necessary space for the removal of the same.

Our drop head is designed completely removable in order to be painted or Hot galvanized following the customer's request.

## Teste fissa LT

Tete fixe LT

Fix head LT

**TESTA FISSA LT  
TETE FIXE LT  
FIX HEAD LT**

<b>DESCRIZIONE</b> DESCRIPTION DESCRIPTION	<b>ARTICOLO</b> ARTICLE ARTICLE	<b>PESO Kg</b> POIDS Kg WEIGHT Kg
	391012LT	1,1

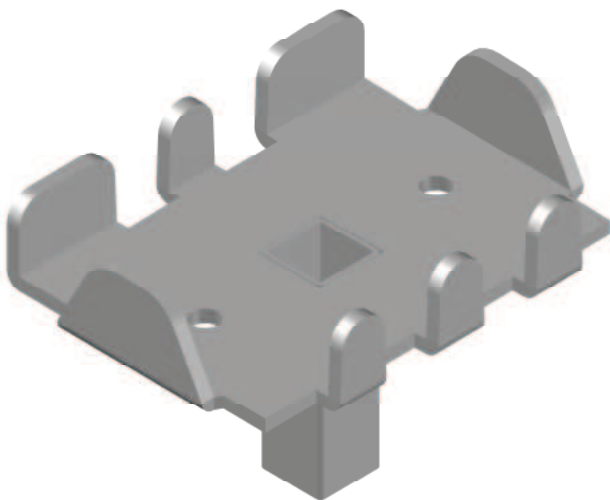

Questo accessorio viene utilizzato per sostenere da uno a quattro pannelli solaio.

Viene fissato tramite due bulloni e dadi ad alette al puntello.

La testa fissa LT può essere usata nelle partenze d'armo, in prossimità delle pareti verticali e permette di sostenere quattro pannelli creando una compensazione di 5 cm.

Cet accessoire est utilisé pour soutenir une à quatre panneaux de plancher.

Est fixé par deux vis et les écrous sur les ailes avec l'étai charge.

La tête LT fixe peut être utilisé dans les départs de montage du system, dans le voisinage des parois verticales et permet de soutenir quatre panneaux créant une compensation de 5 cm.

This accessory is used to support from one to four floor panels.

Is secured by two bolts and wing nuts to the steel prop.

The fixed head LT can be used in the departures of arming, close to the vertical walls and allows you to support four panels creating a compensation of 5 cm.

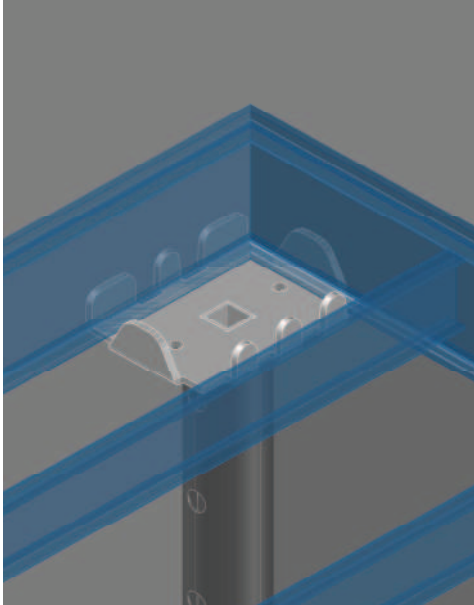

Posizione partenza d'armo solaio.  
Position de départ de montage plancher.  
Starting position for assembly of the ceiling.

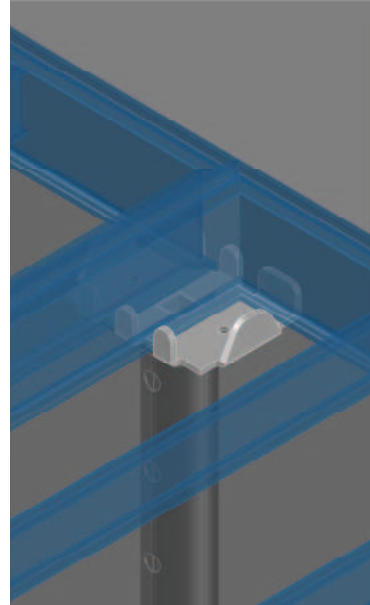

Posizione in prossimità della parete verticale.  
Position dans le voisinage de la paroi verticale.  
Position the element close to the vertical wall.

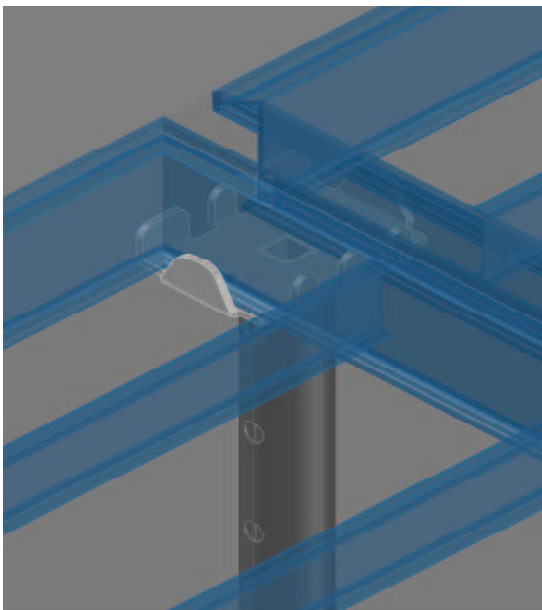

Posizione in prossimità della parete verticale con l'uso della testa cadente LT.  
Position dans le voisinage de la paroi verticale à l'aide de la tête de decintrement LT.  
Position in the vicinity of the vertical wall, using the falling head LT.



Posizione con sostegno quattro pannelli e compesazione di 5 cm  
Position avec le soutien des 4 panneaux et égalant de 5 cm.  
Position to support four panels and support equaling 5 cm

## Teste fissa LT solo pannelli

Tete fixe LT seuls panneaux

Fix head LT only panels

**TESTA FISSA LT SOLO PANNELLI**  
**TETE FIXE LT SEULS PANNEAUX**  
**FIX HEAD LT ONLY PANELS**

DESCRIZIONE DESCRIPTION DESCRIPTION	ARTICOLO ARTICLE ARTICLE	PESO Kg POIDS Kg WEIGHT Kg
	391013LT	0,8

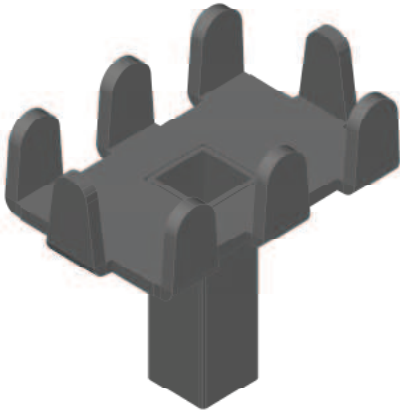

Questo accessorio viene utilizzato per sostenere da due a quattro pannelli solaio.

Viene fissato tramite due bulloni e dadi ad alette al puntello.

La testa fissa LT può essere usata in prossimità delle pareti verticali e permette di sostenere quattro pannelli.

Cet accessoire est utilisé pour soutenir de deux à quatre panneaux de plancher.

Est fixé par deux vis et écrous avec ailes vers l'étais charge en acier.

La tête fixe LT peut être utilisé dans le voisinage des parois verticales et permet de soutenir quatre panneaux.

This accessory is used to support from two to four floor panels.

Is secured by bolts and wing nuts to the steel prop.

The fix head LT can be used in the vicinity of the vertical walls and allows to support up to four panels.

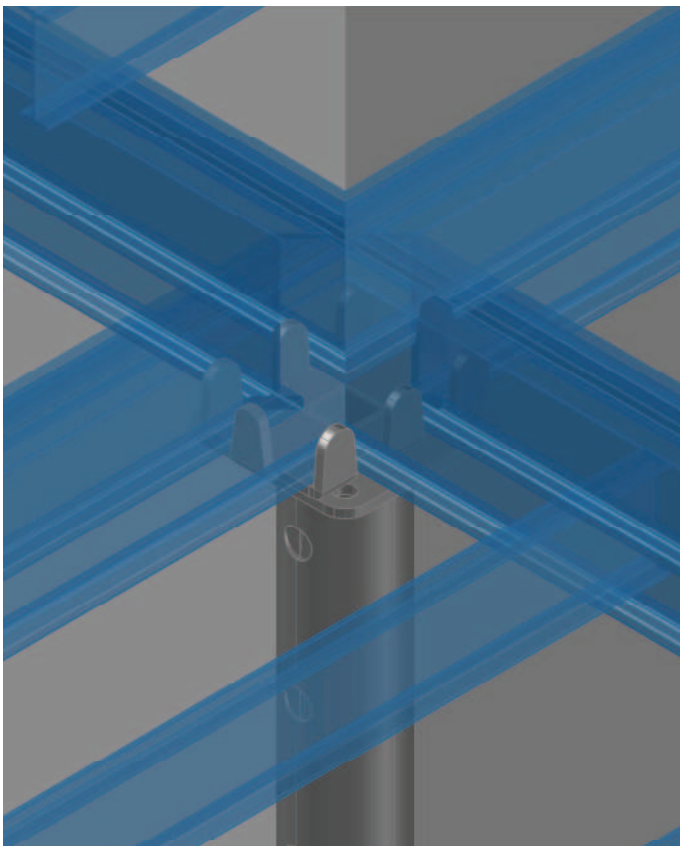

Posizione con sostegno di quattro pannelli solai.  
Position avec le soutien de quatre panneaux de plancher.  
Position with support of four Ceiling panels.

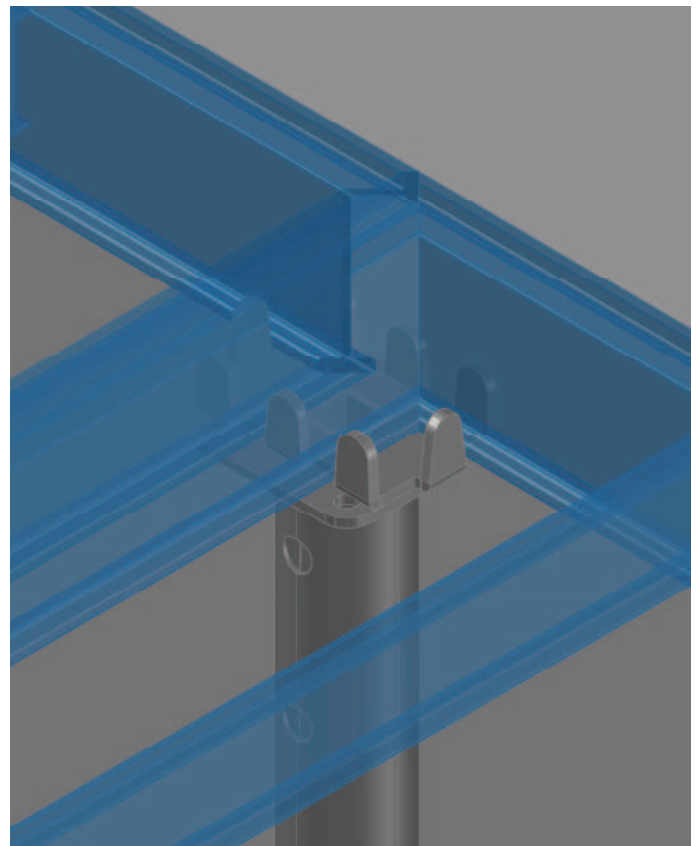

Posizione in prossimità della parete verticale.  
Position dans le voisinage de la paroi verticale.  
Position in the vicinity of the vertical wall.

## Forcella per montaggio

### Fourche de montage

### Mounting fork

**FORCELLA PER MONTAGGIO  
FOURCHE DE MONTAGE  
MOUNTING FORK**

DESCRIZIONE DESCRIPTION DESCRIPTION	ARTICOLO ARTICLE ARTICLE	PESO Kg POIDS Kg WEIGHT Kg
	391080	5,0

Questo accessorio viene utilizzato per sollevare in tutta sicurezza e facilità i pannelli solai in fase d'armo. Esso va ad accoppiarsi perfettamente col profilo di bordo dei pannelli. Il cliente può decidere la finitura esterna: verniciato, zincato a freddo e zincato a caldo.

Cet accessoire est utilisé pour soulever facilement et en sécurité toute panneaux et accessoires lors de l'assemblage.

Il correspond parfaitement au profil du bord des panneaux.

Le client peut choisir la finition: peint, galvanisé a froid et galvanisé à chaud.

This accessory is used to lift easy and safely the Ceiling panels in the process of assembly. It matches perfectly with the profile of the edge of the panels. The customer can choose the finishing of the elements: painted, cold galvanized or hot galvanized.



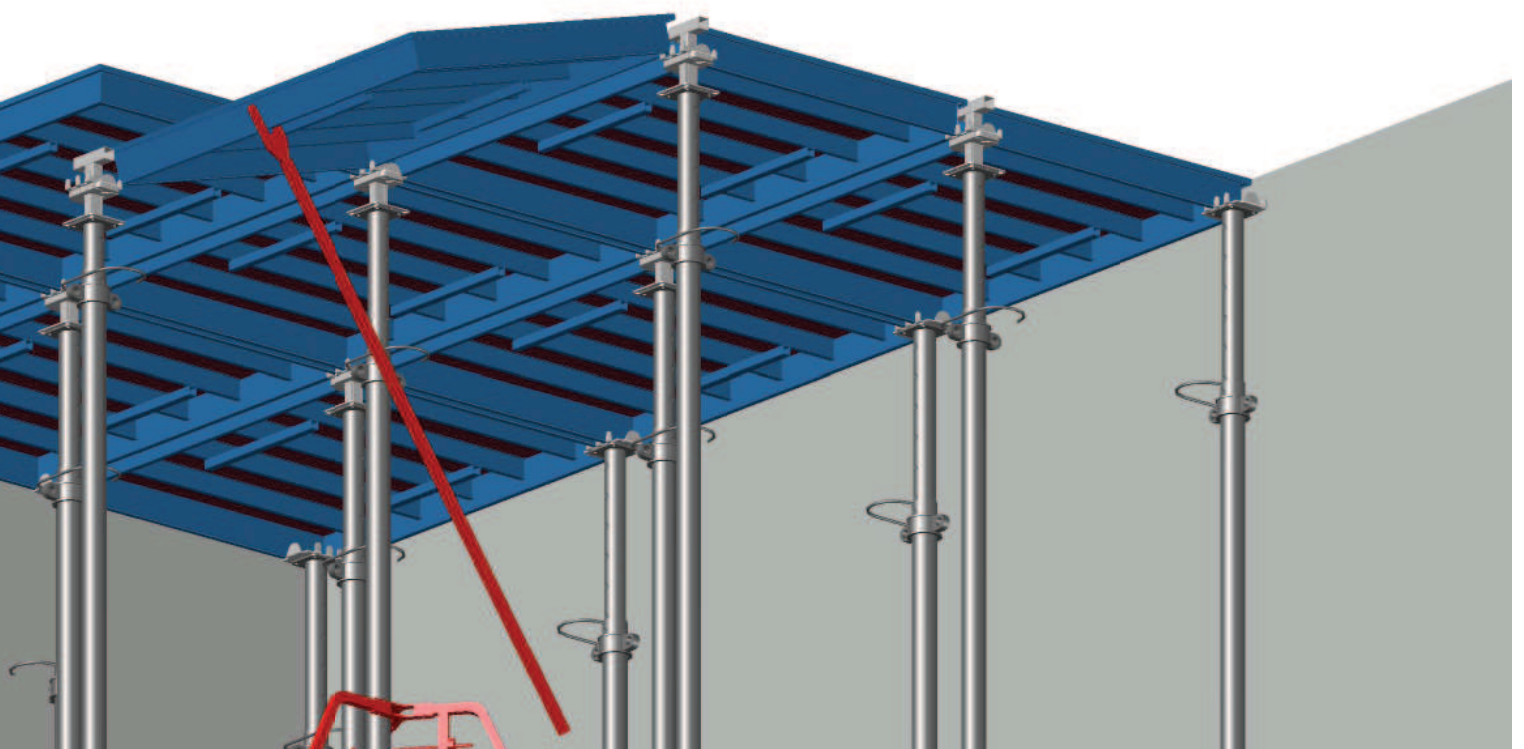
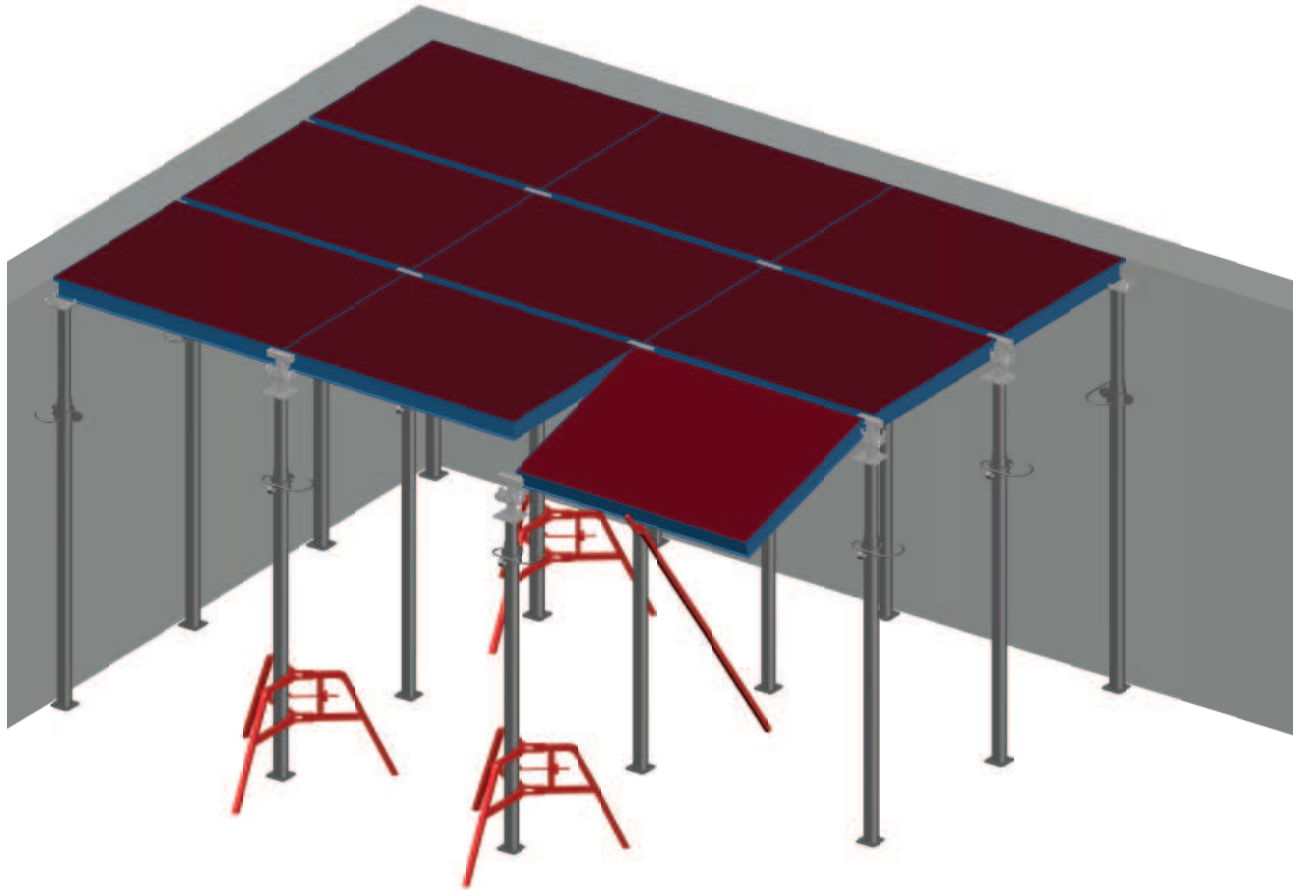



## Profili di chiusura

### Profils de fermeture

### Closing profile

Si tratta di un profilo costituito interamente in alluminio e disponibile in varie lunghezze. In fase di montaggio del solaio viene collocato tra un pannello e l'altro a cavallo delle teste cadenti per compensazione.

Il s'agit d'un profil constitué entièrement en aluminium et disponible en différentes longueurs. Durant la phase de montage de la dalle, il est placé entre un panneau et l'autre, à cheval sur les têtes tombantes pour compensation.

It is a profile entirely in aluminum and available in various lengths. During the assembling phase of the floor it is placed between a panel and the other over the falling parts for compensation.

#### PROFILO DI CHIUSURA

#### PROFILS DE FERMETURE

#### CLOSING PROFILE

DESCRIZIONE DESCRIPTION DESCRIPTION	ARTICOLO ARTICLE ARTICLE	PESO Kg POIDS Kg WEIGHT Kg
L. 150	391030	1
L. 75	391032	0,8
L. 50	391034	0,7
L. 37,5	391036	0,4

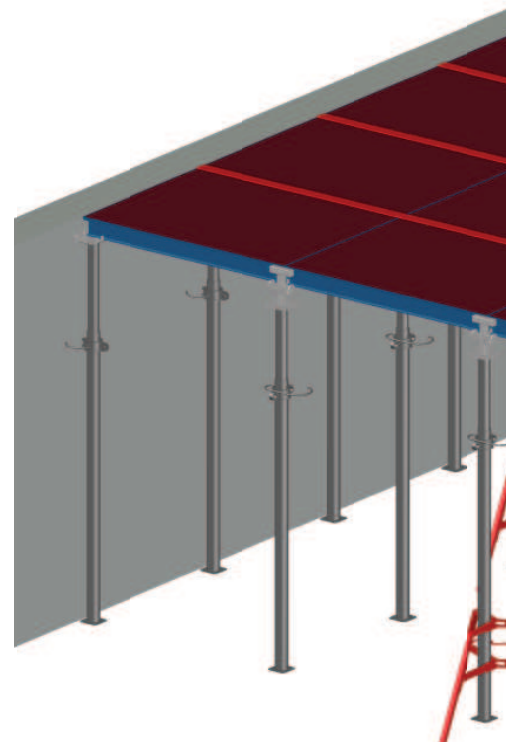
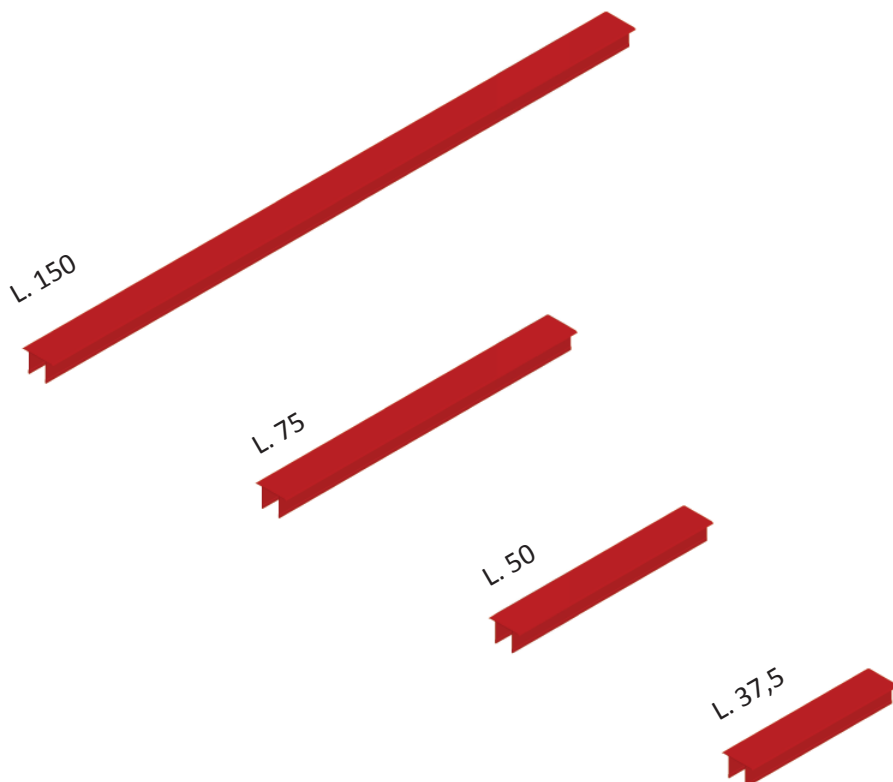

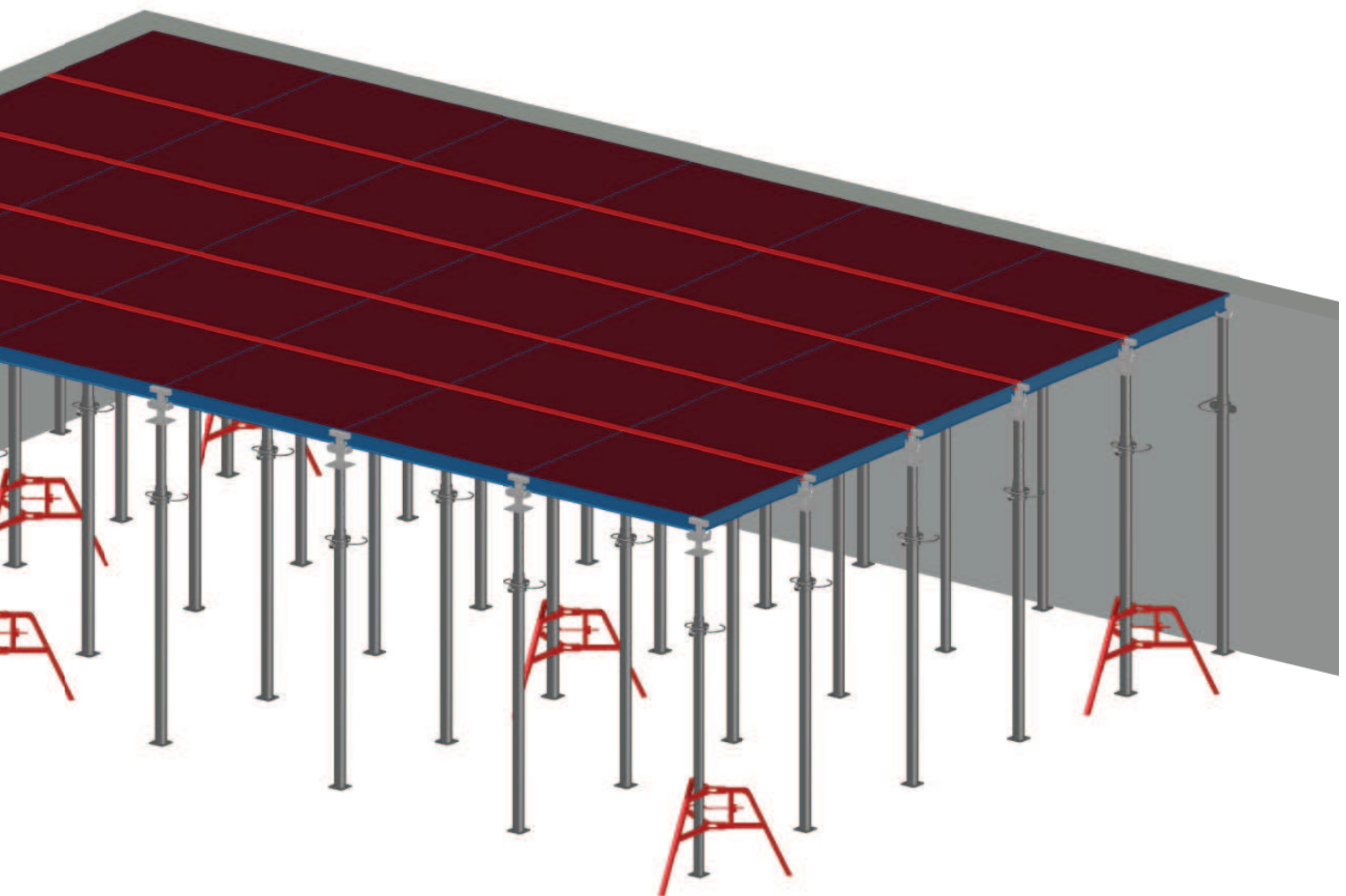
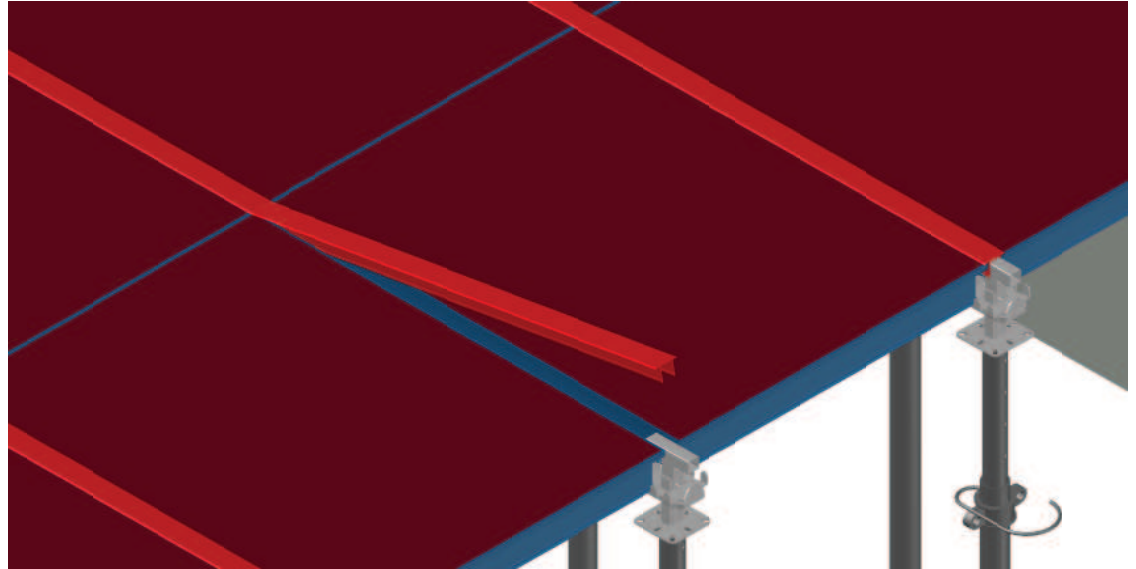

Cantiere edilizia privata, Bellinzona, Svizzera  
Chantier de travaux publics, Bellinzona, Suisse  
Public building site, Bellinzona, Switzerland



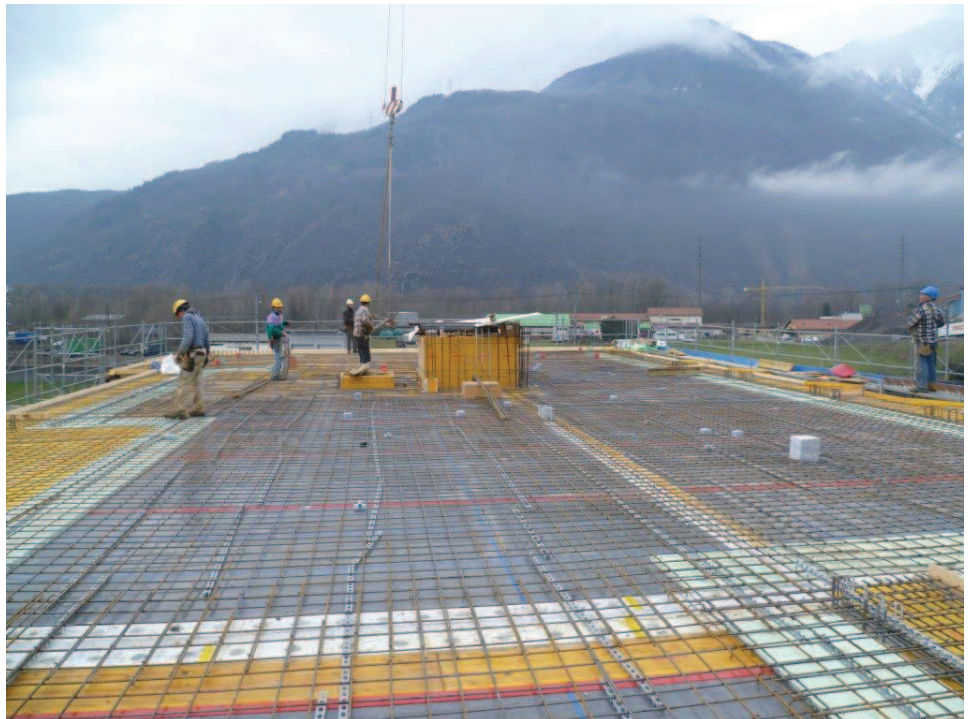

# Smontaggio Walk-Deck LT

## Demontage systeme de coffrage dalle Walk-Deck LT

### Dismantling Walk-Deck LT

Questo sistema prevede un rapido e semplice smontaggio di tutti i pannelli in alluminio con la possibilità di recuperare il materiale dopo qualche giorno per la fase successiva.

Per il disarmo è necessario agire con il martello sul cuneo delle teste cadenti per farle abbassare e poter recuperare il materiale descritto sopra.

Una volta disarmato resteranno in posizione tutti i puntelli con le varie teste cadenti LT ed i profili di chiusura fino al raggiungimento totale della maturazione del getto.

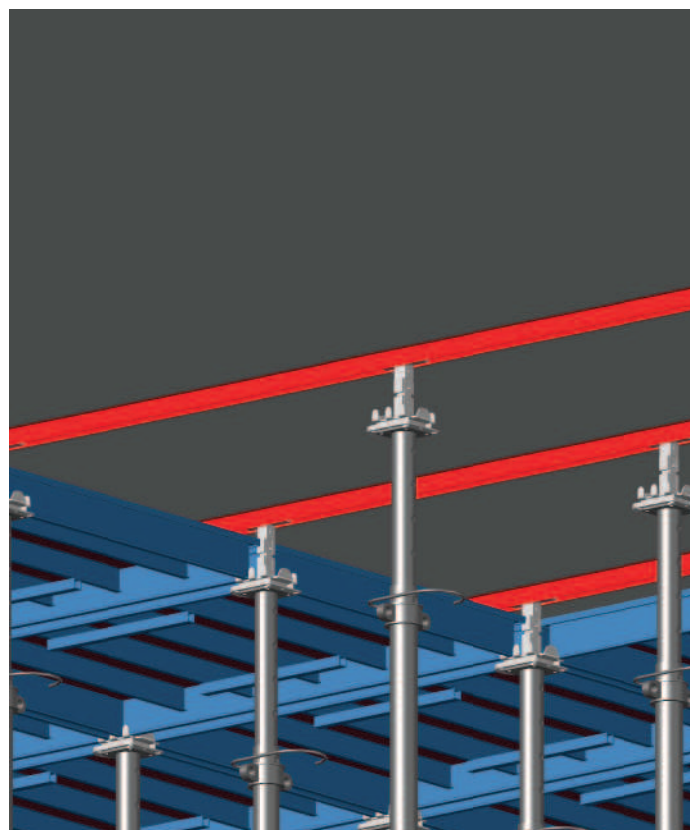

Ce système permet un démontage rapide et facile de toutes les panneaux en aluminium avec la possibilité de récupération du matériau au bout de quelques jours, de la coulée de la dalle à l'étape de travail suivante.

Pour le désarmement est nécessaire d'agir avec le marteau sur les coin de têtes de decintrement inférieure pour eux et être en mesure de récupérer le matériel décrit ci-dessus.

Une fois désarmé restera en place tous les etais charge acier avec le tetes de decintrement LT et les sections de fermeture jusqu'à ce qu'il atteigne la maturation complète du jet.

(Ce pourcentage peut varier en fonction du type de beton utilisé, à la température ambiante et à la direction du chantier).

The Nicoletti International Walk-Deck LT, provides a quick and easy disassembly of all the aluminum panels with the possibility of recovering the material after a few days for the next phase.

Disarmament is necessary to act with the hammer on the wedge heads drooping lower for them and be able to recover the material described above.

Once disarmed remain in position, the majority of the drop heads LT and of steel props together with the respective closing profile until the total maturity of the concrete (this varies based on the type of concrete used, climatic conditions, and in base of the supervision of works).

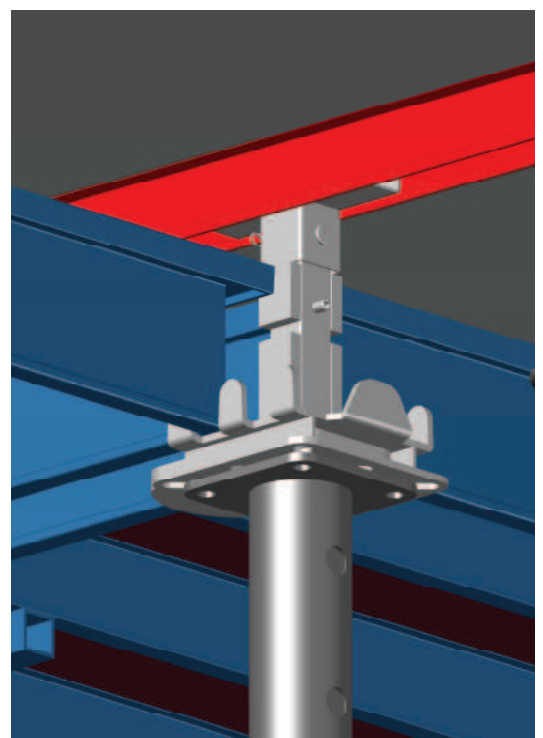
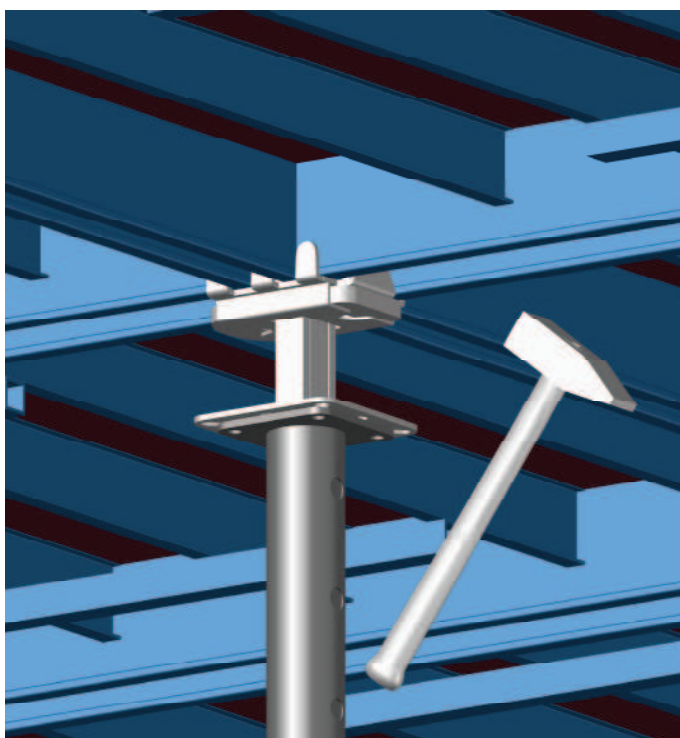
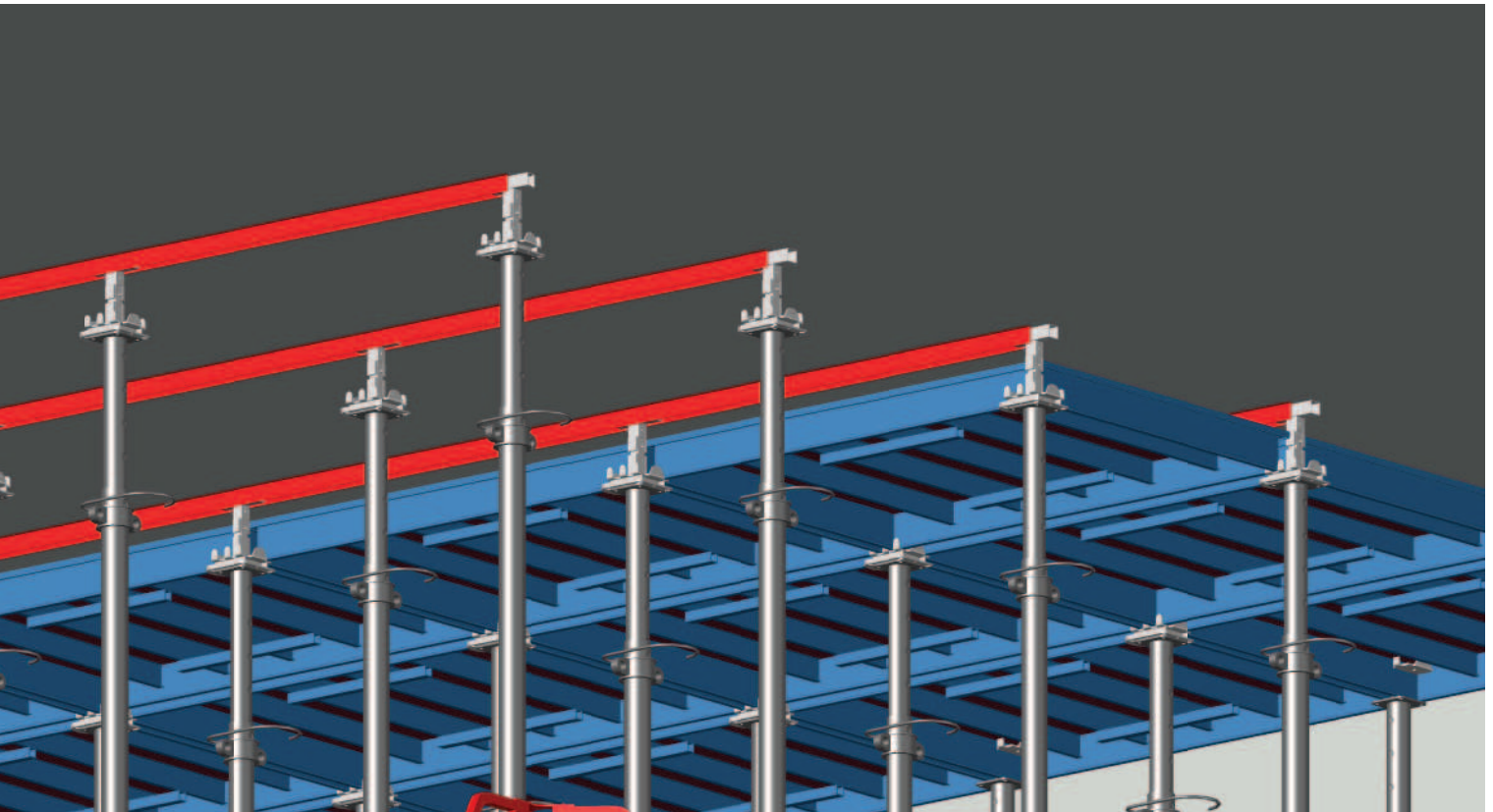

## Accessori

### Accessoires

### Accessories

Accessorio formato da un profilo ad U metallico con inserito all'interno un listello in legno, disponibile in varie lunghezze è necessario per compensazioni in particolare "giro pilastri" o a fine parete. Prevede l'appoggio di pannelli da 27, 21 e 18 mm. per il tamponamento.

Accessoire formé par un profil en U métallique avec une latte en bois qui est insérée à l'intérieur, disponible en différentes longueurs, il est nécessaire pour les compensations et, notamment, dans les "tours des piliers" ou à la fin d'une paroi. Il prévoit l'appui de panneaux de 27, 21 et de 18 mm pour le remplissage.

It is an accessory formed by a metallic U shaped profile with inserted a wooden slat, available in different lengths, it is necessary for compensations as "boundary pillars" or as ending wall.

It is planned for supporting panels of 27, 21 and 28 mm for the wall pin.

PROFILO DI COMPENSO PROFIL DE COMPENSATION COMPENSATION PROFILE			
DESCRIZIONE DESCRIPTION DESCRIPTION	ARTICOLO ARTICLE ARTICLE	PESO Kg POIDS Kg WEIGHT Kg	
L. 150	391038-27	6,0	
L. 75	391040-27	3,0	
L. 50	391042-27	2,0	
L. 37,5	391044-27	1,0	
L. 150	391038-21	6,0	
L. 75	391040-21	3,0	
L. 50	391042-21	2,0	
L. 37,5	391044-21	1,0	
L. 150	391038-18	6,0	
L. 75	391040-18	3,0	
L. 50	391042-18	2,0	
L. 37,5	391044-18	1,0	

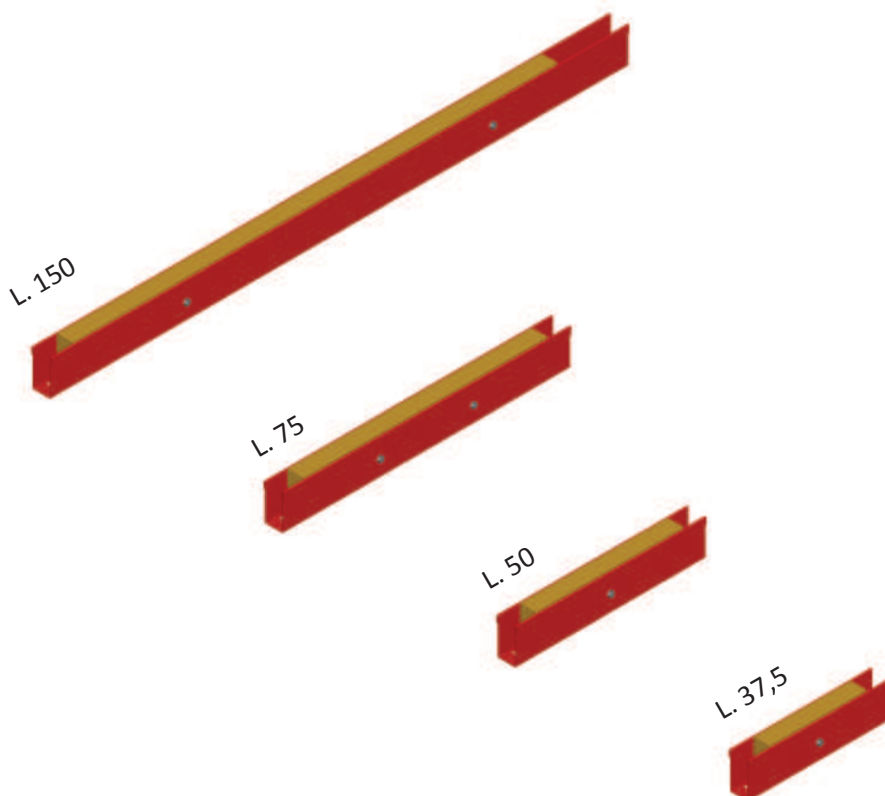



**STAFFA ANCORAGGIO PARETE**  
**ETRIER D'ANCRAGE PAROIS**  
**ANCHORING WALL BRACKET**

DESCRIZIONE DESCRIPTION DESCRIPTION	ARTICOLO ARTICLE ARTICLE	PESO Kg POIDS Kg WEIGHT Kg
	391054	20,0



**MORSETTO PANNELLO PANNELLO**  
**BRIDE POUR PANNEAU**  
**PANEL CLAMP**

DESCRIZIONE DESCRIPTION DESCRIPTION	ARTICOLO ARTICLE ARTICLE	PESO Kg POIDS Kg WEIGHT Kg
	391058	1,5



**SQUADRA PER SPONDINA**  
**EQUERRE POUR BORD**  
**SQUARE FOR SIDE EDGE**

DESCRIZIONE DESCRIPTION DESCRIPTION	ARTICOLO ARTICLE ARTICLE	PESO Kg POIDS Kg WEIGHT Kg
	391062	3,0



# Contenitori

## Paniers

### Container



#### PIANALE PER PANNELLI SOLAIO CHÂSSIS POUR PANNEAUX DALLE PLATFORM FOR FLOOR PANELS

DESCRIZIONE DESCRIPTION DESCRIPTION	ARTICOLO ARTICLE ARTICLE	PESO Kg POIDS Kg WEIGHT Kg
	391080	90,0

Capacità: N° 48 PANNELLI SOLAIO AL 150X75  
Capacite: N° 48 PANNEAUX DALLE AL 150X75  
Capacity: N° 48 FLOOR PANEL AL 150X75



#### CRICCHETTO CON FASCIA CLIQUET AVEC BAND RATCHET WITH BELT

DESCRIZIONE DESCRIPTION DESCRIPTION	ARTICOLO ARTICLE ARTICLE	PESO Kg POIDS Kg WEIGHT Kg
	391082	1,0

#### CONTENITORE SINGOLO PER PANNELLI SOLAIO PANIER SIMPLE POUR COFFRAGE DALLE CONTAINER FOR PANELS

DESCRIZIONE DESCRIPTION DESCRIPTION	ARTICOLO ARTICLE ARTICLE	PESO Kg POIDS Kg WEIGHT Kg
	391084	102,0

Capacità: N° 10 PANNELLI SOLAIO AL 150X75  
Capacite: N° 10 PANNEAUX DALLE AL 150X75  
Capacity: N° 10 FLOOR PANEL AL 150X75



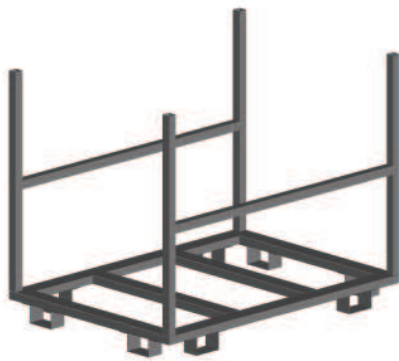

**CONTENITORE PER TRAVI E PUNTELLI  
PANIERI POUR POUTRES ET ETAIS  
CONTAINER FOR BEAMS / PROPS**

DESCRIZIONE DESCRIPTION DESCRIPTION	ARTICOLO ARTICLE ARTICLE	PESO Kg POIDS Kg WEIGHT Kg
	391086	110,0

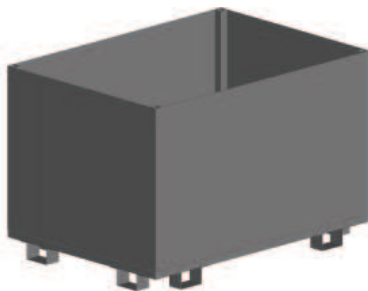

**CONTENITORE ACCESSORI 160X80  
PANIERI POUR ACCESSOIRES 160X80  
ACCESSORIES CONTAINER 160X80**

DESCRIZIONE DESCRIPTION DESCRIPTION	ARTICOLO ARTICLE ARTICLE	PESO Kg POIDS Kg WEIGHT Kg
	391088	90,0



**CONTENITORE 120X80  
PANIERI 120X80  
CONTAINER 120X80**

DESCRIZIONE DESCRIPTION DESCRIPTION	ARTICOLO ARTICLE ARTICLE	PESO Kg POIDS Kg WEIGHT Kg
	296053	60,0
CON DIVISORI AVEC SÉPARATEURS WITH DIVIDERS	296054	65,0

## PUNTELLAZIONE - ETAIS - PROPPING

Puntelli in acciaio  
Etais en acier / Steel prop

25/36



Per il corretto utilizzo di ogni sistema di prodotto è obbligato consultare il relativo manuale d'uso.  
Esso può subire costanti aggiornamenti e revisioni senza nostro preavviso.  
E' responsabilità dell'utilizzatore assicurarsi di essere in possesso della versione più recente del manuale stesso.

Pour la bonne utilisation de chaque système de produit est nécessaire, se référer au manuel d'utilisation.  
Il peut subir des mises à jour et des révisions constantes sans notre avis.  
Et la «responsabilité de vous assurer que vous avez la dernière version du manuel.

For the appropriate use of each product system it is obligatory to consult the specific manual of instruction.  
Each manual may be our constant updates and revisions without prior notice.  
It is the user's responsibility to make sure of possessing the most recent and updated version of the manual.

## PUNTELLAZIONE

### ETAIS - PROPPING



## Steel props DIN EN CLASSE B

Etais en acier DIN EN CLASSE B

Steel props DIN EN CLASSE B



### VERNICIATO VERNI VARNISHED

DESCRIZIONE DESCRIPTION DESCRIPTION	ARTICOLO ARTICLE ARTICLE	PESO Kg POIDS Kg WEIGHT Kg
B25 151-250	411311	13,0
B30 179-300	411312	15,1
B35 201-350	411313	16,9
B40 231-400	411314	18,6
B45 255-450	411315	21,6

### ZINCATO FREDDO ZINGUE A FROID COLD GALVANIZED

DESCRIZIONE DESCRIPTION DESCRIPTION	ARTICOLO ARTICLE ARTICLE	PESO Kg POIDS Kg WEIGHT Kg
B25 151-250	411321	13,0
B30 179-300	411322	15,1
B35 201-350	411323	16,9
B40 231-400	411324	18,6
B45 255-450	411325	21,6

### ZINCATO CALDO ZINGUE A CHAUD HOT GALVANIZED

DESCRIZIONE DESCRIPTION DESCRIPTION	ARTICOLO ARTICLE ARTICLE	PESO Kg POIDS Kg WEIGHT Kg
B25 151-250	411331	13,7
B30 179-300	411332	15,9
B35 201-350	411333	17,6
B40 231-400	411334	19,3
B45 255-450	411335	22,3

ESTENSIONE (cm) EXTENSION (cm) EXTENSION (cm)	PORTATA (KN) PORTEE (KN) LOADING (KN)				
	B30	B35	B40	B45	
	180	30,00			
	190	30,00			
200	30,00	30,00			
210	27,21	30,00			
220	24,79	28,93			
230	22,68	26,47	30,00		
240	20,83	24,31	27,78	30,00	
250	19,20	22,40	25,60	28,80	
260	17,75	10,71	23,67	26,63	
270	16,46	19,20	21,95	24,69	
280	15,31	17,86	10,41	22,96	
290	14,27	16,65	19,02	21,40	
300	13,33	15,56	17,78	20,00	
310		14,57	16,65	18,73	
320		13,67	15,63	17,58	
330		12,86	14,69	16,53	
340		12,11	13,84	15,57	
350		11,43	13,06	14,69	
360			12,35	13,89	
370			11,69	13,15	
380			11,08	12,47	
390			10,52	11,83	
400			10,00	11,25	
410				10,71	
420				10,20	
430				9,73	
440				9,30	
450				8,89	

## Puntelli in Acciaio DIN EN CLASSE C

Etais en acier DIN EN CLASSE C

Steel props DIN EN CLASSE C



### VERNICIATO VERNI VARNISHED

DESCRIZIONE DESCRIPTION DESCRIPTION	ARTICOLO ARTICLE ARTICLE	PESO Kg POIDS Kg WEIGHT Kg
C/E30 179-300	411411	17,1
C/D35 201-350	411412	19,5
C40 231-400	411413	23,9
C45 255-450	411414	25,6
C55 301-550	411415	29,6

### ZINCATO FREDDO ZINGUE A FROID COLD GALVANIZED

DESCRIZIONE DESCRIPTION DESCRIPTION	ARTICOLO ARTICLE ARTICLE	PESO Kg POIDS Kg WEIGHT Kg
C/E30 179-300	411421	17,1
C/D35 201-350	411422	19,5
C40 231-400	411423	23,9
C45 255-450	411424	25,6
C55 301-550	411425	29,6

### ZINCATO CALDO ZINGUE A CHAUD HOT GALVANIZED

DESCRIZIONE DESCRIPTION DESCRIPTION	ARTICOLO ARTICLE ARTICLE	PESO Kg POIDS Kg WEIGHT Kg
C/E30 179-300	411431	18,0
C/D35 201-350	411432	20,5
C40 231-400	411433	24,8
C45 255-450	411434	26,5
C55 301-550	411435	30,6

ESTENSIONE (cm) EXTENSION (cm) EXTENSION (cm)	PORTATA (KN) PORTEE (KN) LOADING (KN)				
	C/E30	C/D35	C40	C45	C55
180	35,00				
190	35,00				
200	35,00	35,00			
210	35,00	35,00			
220	35,00	35,00			
230	34,03	35,00	35,00		
240	31,25	35,00	35,00		
250	30,00	33,60	35,00	35,00	
260	30,00	31,07	35,00	35,00	
270	30,00	28,81	32,92	35,00	
280	30,00	26,79	30,61	34,44	
290	30,00	24,97	28,54	32,10	
300	30,00	23,33	26,67	30,00	35,00
310		21,85	24,97	28,10	34,34
320		20,51	23,44	26,37	32,23
330		20,00	22,04	24,79	30,30
340		20,00	20,76	23,36	28,55
350		20,00	19,59	22,04	26,94
360			18,52	20,83	25,46
370			17,53	19,72	24,11
380			16,62	18,70	22,85
390			15,78	17,75	21,70
400			15,00	16,87	20,62
410				16,06	19,63
420				15,31	18,71
430				14,60	17,85
440				13,95	17,05
450				13,33	16,30
460					15,60
470					14,94
480					14,32
490					13,74
500					13,20
510					12,69
520					12,20
530					11,75
540					11,32
550					10,91



# Puntelli in Acciaio DIN EN CLASSE D

Etais en acier DIN EN CLASSE D

Steel props DIN EN CLASSE D



## VERNICIATO VERNI VARNISHED

DESCRIZIONE DESCRIPTION DESCRIPTION	ARTICOLO ARTICLE ARTICLE	PESO Kg POIDS Kg WEIGHT Kg
B/E30 179-300	411511	16,2
C/D35 201-350	411512	19,5
D40 231-400	411513	23,9
D45 255-450	411514	27,0
D50 281-500	411515	34,1

## ZINCATO FREDDO ZINGUE A FROID COLD GALVANIZED

DESCRIZIONE DESCRIPTION DESCRIPTION	ARTICOLO ARTICLE ARTICLE	PESO Kg POIDS Kg WEIGHT Kg
B/E30 179-300	411521	16,2
C/D35 201-350	411522	19,5
D40 231-400	411523	23,9
D45 255-450	411524	27,0
D50 281-500	411525	34,1

## ZINCATO CALDO ZINGUE A CHAUD HOT GALVANIZED

DESCRIZIONE DESCRIPTION DESCRIPTION	ARTICOLO ARTICLE ARTICLE	PESO Kg POIDS Kg WEIGHT Kg
B/E30 179-300	411531	16,9
C/D35 201-350	411532	20,5
D40 231-400	411533	24,8
D45 255-450	411534	28,0
D50 281-500	411535	35,0

ESTENSIONE (cm) EXTENSION (cm) EXTENSION (cm)	PORTATA (KN) PORTEE (KN) LOADING (KN)				
	B/D30	C/D35	D40	D45	D50
	180	30,00			
190	30,00				
200	30,00	35,00			
210	27,21	35,00			
220	24,79	35,00			
230	22,68	35,00	20,00		
240	20,83	35,00	20,00		
250	20,00	33,60	20,00		
260	20,00	31,07	20,00	20,00	
270	20,00	28,81	20,00	20,00	
280	20,00	26,79	20,00	20,00	20,00
290	20,00	24,97	20,00	20,00	20,00
300	20,00	23,33	20,00	20,00	20,00
310		21,85	20,00	20,00	20,00
320		20,51	20,00	20,00	20,00
330		20,00	20,00	20,00	20,00
340		20,00	20,00	20,00	20,00
350		20,00	20,00	20,00	20,00
360			20,00	20,00	20,00
370			20,00	20,00	20,00
380			20,00	20,00	20,00
390			20,00	20,00	20,00
400			20,00	20,00	20,00
410				20,00	20,00
420				20,00	20,00
430				20,00	20,00
440				20,00	20,00
450				20,00	20,00
460					20,00
470					20,00
480					20,00
490					20,00
500					20,00

## Puntelli in Acciaio DIN EN CLASSE E

Etais en acier DIN EN CLASSE E

Steel props DIN EN CLASSE E



### VERNICIATO VERNI VARNISHED

DESCRIZIONE DESCRIPTION DESCRIPTION	ARTICOLO ARTICLE ARTICLE	PESO Kg POIDS Kg WEIGHT Kg
E25 151-250	411611	15,1
C/E30 179-300	411612	17,1
E35 201-350	411613	20,7
E40 231-400	411614	26,6
E45 255-450	411615	31,4

### ZINCATO FREDDO ZINGUE A FROID COLD GALVANIZED

DESCRIZIONE DESCRIPTION DESCRIPTION	ARTICOLO ARTICLE ARTICLE	PESO Kg POIDS Kg WEIGHT Kg
E25 151-250	411621	15,1
C/E30 179-300	411622	17,1
E35 201-350	411623	20,7
E40 231-400	411624	26,6
E45 255-450	411625	31,4

### ZINCATO CALDO ZINGUE A CHAUD HOT GALVANIZED

DESCRIZIONE DESCRIPTION DESCRIPTION	ARTICOLO ARTICLE ARTICLE	PESO Kg POIDS Kg WEIGHT Kg
E25 151-250	411631	16,0
C/E30 179-300	411632	18,0
E35 201-350	411633	21,6
E40 231-400	411634	27,5
E45 255-450	411635	32,5

ESTENSIONE (cm) EXTENSION (cm) EXTENSION (cm)	PORTATA (KN) PORTEE (KN) LOADING (KN)					
	E25	C/E30	E35	E40	E45	
	150	30,00				
	160	30,00				
170	30,00					
180	30,00	35,00				
190	30,00	35,00				
200	30,00	35,00	30,00			
210	30,00	35,00	30,00			
220	30,00	35,00	30,00			
230	30,00	34,03	30,00	30,00		
240	30,00	31,25	30,00	30,00		
250	30,00	30,00	30,00	30,00	30,00	
260		30,00	30,00	30,00	30,00	
270		30,00	30,00	30,00	30,00	
280		30,00	30,00	30,00	30,00	
290		30,00	30,00	30,00	30,00	
300		30,00	30,00	30,00	30,00	
310			30,00	30,00	30,00	
320			30,00	30,00	30,00	
330			30,00	30,00	30,00	
340			30,00	30,00	30,00	
350			30,00	30,00	30,00	
360				30,00	30,00	
370				30,00	30,00	
380				30,00	30,00	
400				30,00	30,00	
410					30,00	
420					30,00	
430					30,00	
440					30,00	
450					30,00	

Edizione 2015

©Copyright by Nicoletti International SRL

Il catalogo è soggetto a variazioni da parte del produttore.

E' vietata la riproduzione e/o trasmissione di questo catalogo in qualsiasi forma o mezzo elettronico, chimico o meccanico, copie fotostatiche incluse, come pure con sistemi di archiviazione e ricerca delle informazioni senza l'autorizzazione scritta da parte del proprietario del copyright.

2015 Edition

©Copyright by Nicoletti International SRL

Le catalogue peut subir des variations effectuées par le producteur.

La reproduction et/ou la transmission de ce catalogue, sous n'importe quelle forme ou moyen électronique, chimique ou mécanique, y compris les photocopies, ainsi que les systèmes d'archivage et de recherche des informations, est formellement interdite sans l'autorisation écrite de la part du propriétaire du copyright.

2015 Edition

Copyright by Nicoletti International SRL

The catalogue is subject to variations by the manufacturer.

It is forbidden the reproduction and/or transmission of the catalogue by any form or means as electronic, chemical or mechanical, photostatic copies included, but also through archiving systems and research of information without the written authorization by the owner of the copyright.



Fabbricati da | Made by | Fabriqué par | Fabricado por  
**Nicoletti International S.r.l. & Partners**  
Via Monte Verlaldo 48 36073 Cornedo Vicentino (VI) IT  
[info@nicoletti-international.com](mailto:info@nicoletti-international.com) | +39 0445 192 2225



Tutte le immagini ed i dati tecnici sono a titolo indicativo e potranno essere modificati senza preavviso.  
All images and technical data are for illustrative purposes and can be changed without prior notice.  
Toutes les images et les données techniques sont indicatives et peuvent être changées sans préavis.  
Todas las imágenes y los datos técnicos son ilustrativos y podrán ser modificados sin previo aviso.  
CAT-NI - 26 Walk-Deck - 2022-02 IT|EN|FR|02|2022|RCA - ©Nicoletti International, S.r.l.

[www.nicoletti-international.com](http://www.nicoletti-international.com)